

DF700 Gas Fireplace

Information Sheet for Builders and Architects

FIRE BY **escea.**

SPECIFICATIONS

Heat Output	5.4 - 5.8 kw
Gas Input	23 MJ/hr (NG) 23 MJ/hr (ULPG/Propane)
Gas Connection	Lower rear of fireplace - 1/2" BSPT Female
Gas Type	Natural Gas or Propane or ULPG
Power Requirement	3 pin, 230V AC mains power within 1m
Operation	Thermostatic Bluetooth remote control
Appliance Weight	58kg
Connections	Lower right of fireplace
Clearance to Combustibles	Zero clearance from fireplace surfaces
Service Access Hatch	Not Required
Cavity Wall Venting	Not Required
Certification	Complies with AS/NZS 5263.1.3
Installation Compliance	AS/NZS5601.1 and DF Series Install Manual



Flue System	Power direct-vent with 100/75mm Ø flexible and rigid PP flue pipes†
Flue Termination Locations	Roof or wall mounted terminations
Minimum Flue Length	400mm
Max. Uninsulated Flexible Flue Length	4m
Max. Insulated Flexible Flue Length	12m†
Max. Flue Length	40m†
Flue Clearances to Combustibles	50mm for the first 900mm of flue run
Flue Bends Allowed	Max. 10 bends in any flue run

CAVITY INSTALLATION OPTION

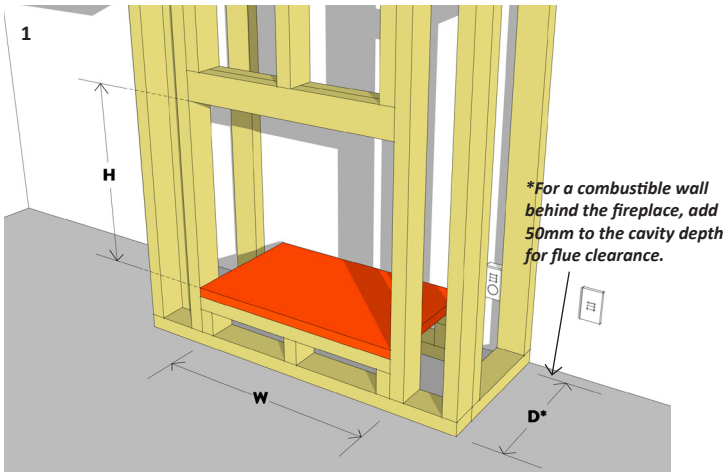

Build the chimney framework to meet the minimum fireplace opening requirements: 695mm W x 600mm H x 400mm D*. Provide a 30mm thick base to allow for the fascia overhang below the fireplace.

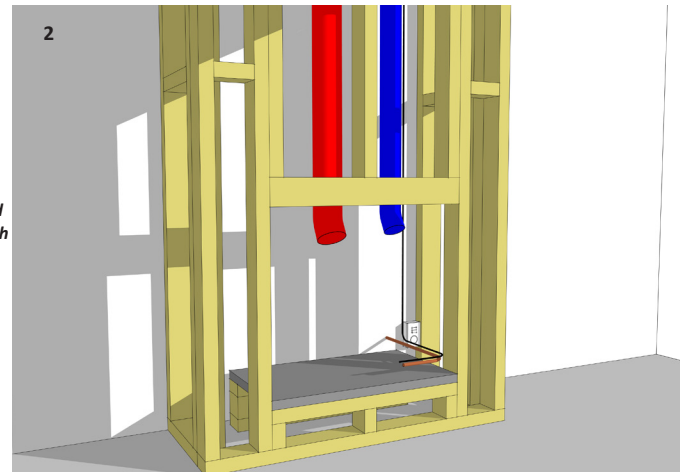

Prepare electrical, network connections, and gas supply. Run the flue pipes through the chosen pathway to the flue terminal. Connect Powerflue electrical cable at both ends.

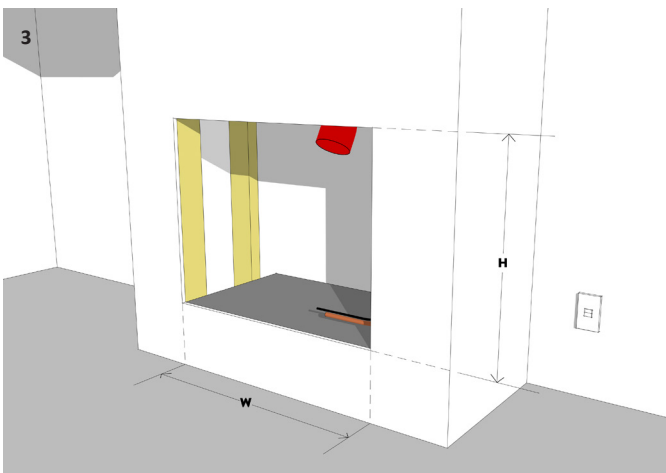

Attach wall linings to the framework, following the provided wall lining cutout dimensions: 695mm W x 560mm H. Fit the spigot plate to the flue pipes.

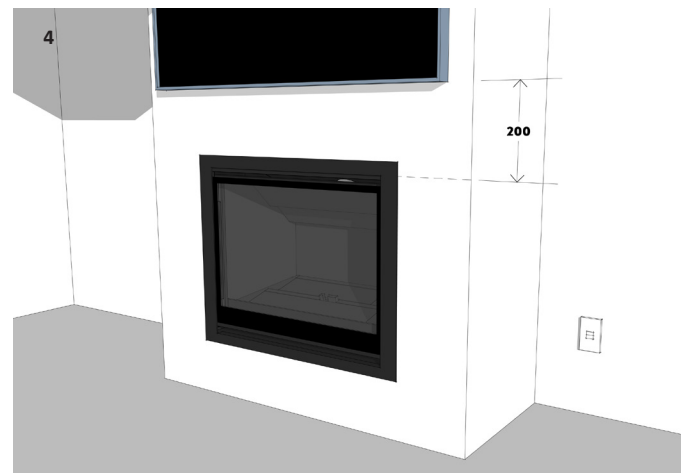

Install the appliance into the preformed cavity opening, fitting the flue spigot and connections as you go. Ensure the fireplace finishes over the wall lining. Fit the fascia. Complete the project by adding additional finishes or fixtures.

† Refer to the Escea DF Series Flue Specification Guide

FIREPLACE AND CAVITY DIMENSIONS

Fireplace Width (A)	690mm
Fireplace Height (B)	598mm
Fireplace Height (C) <i>without Standoff Bracket</i>	558mm
Fireplace Depth (D)	396mm
Glass Viewing Area Width	620mm
Glass Viewing Area Height	464mm
Framed Cavity Opening Width min.	695mm
Framed Cavity Opening Height min.	600mm
Framed Cavity Opening Depth min.	400mm*

*Cavity dimension does not include the 50mm flue clearance to a combustible material.

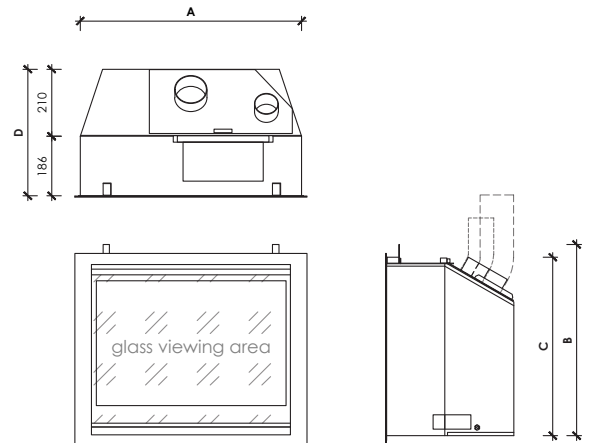

CAVITY OPTIONS

The DF700 gas fireplace is versatile cassette style fireplace for room installations in different configurations. The cavity can be made from various materials, both combustible and non-combustible. The interior of the cavity does not need to be lined, but extra heat protection may be necessary for joinery specifications.

MASONRY INSTALLATION

The DF700 gas fireplace fits masonry cavities and benefits from a fully non-combustible structure with minimised clearances. Installation requires a minimum opening size of **695mm W x 560mm H x 400mm D**.

FIREPLACE BASE

Install the fireplace on a minimum 12mm firm, continuous surface such as concrete, or a framed structure overlaid with plywood, or compressed cement sheet. When placing the DF700 at floor level, raise the fireplace base to allow for the fascia overhang: **30mm for Slim/Stretch Fascia, 55mm for Edge Fascia**.

TV CLEARANCE

When mounting a TV or electrical appliance above a fireplace, this can be completed surface-mounted or recessed. Ensure the TV's base is at least **200mm** above the appliance opening. Note that any TV clearance is a recommendation only, and Escea is not responsible for their compatibility with all electrical appliances.

FIREPLACE CLEARANCES TO COMBUSTIBLE MATERIALS

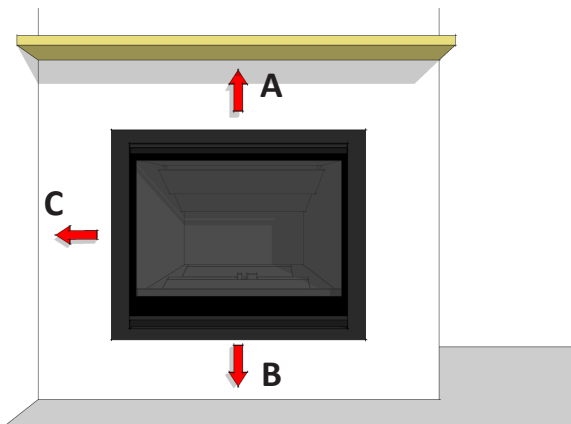

WALL LINING INSTALLATION

Use **10mm to 20mm deep wall linings or finishes**, taking care to select materials suitable for the installation. Ensure the wall lining extends below the lintel and to the top of the fireplace as shown below. Fold down the standoff bracket prior to lining. The fireplace flanges are designed to sit on top of the finished wall surface, and the fascia will cover this junction. For specific finish details, refer to: www.escea.com/fireplace-specification

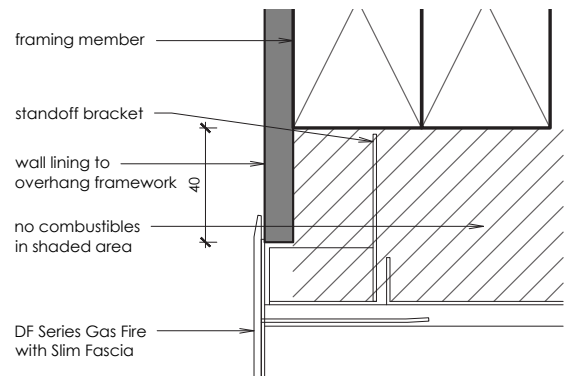

Clearance Guidelines: Adhere to combustible building material clearances in all directions around the fireplace: front clearance **1000mm**.

Mantels (A): Place combustible mantels or protruding ledges above the fireplace at least **200mm** above the appliance opening. Mantel height depends on its depth; the greater the protrusion, the higher the clearance.

Fireplace Elevation (B): Elevate the fireplace **100mm** above a combustible floor or install at floor level on a heat-resistant floor, allowing for the fascia overhang.

Raised Hearth: A raised hearth must either be **100mm** below the fascia if combustible or fully constructed of non-combustible materials.

Side Wall (C): Maintain a distance of **200mm** from the side of the fascia, where a side wall extends forward of the fireplace.

Optional Floor Hearth: When the fireplace is at floor level, a non-combustible hearth will safeguard combustible or heat-sensitive flooring. Dimensions should extend by at least 200mm from the fireplace and match its width. Do not obstruct the fireplace.



For Installation methods not covered in this document please contact:
Email: aa@escea.com PH (NZ): 0800 17 3000 PH (AU): 1800 460 832

Install Manual and CAD files are available via the QR Code or link:
www.escea.com/technical

Disclaimer:

Dimensions provided are indicative and may not consider all site-specific variations or installation needs. Verify dimensions on-site before manufacturing or construction.