

ESCEA DL850: INSET FASCIA - RECESSED

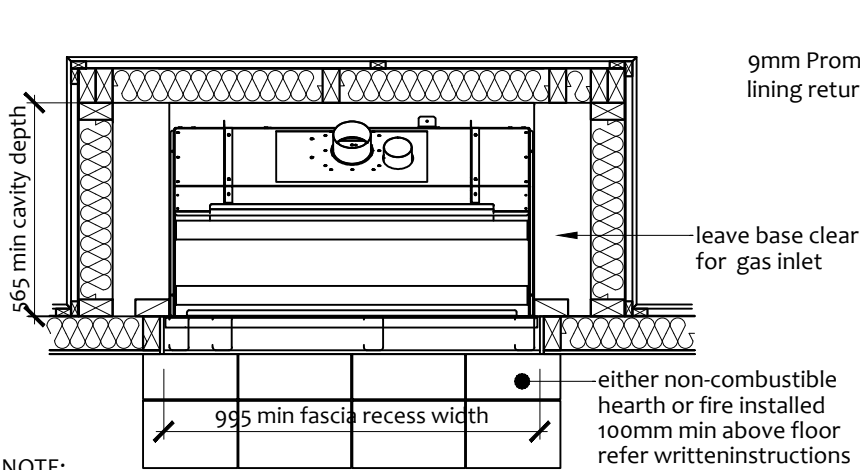

NOTE: WALL LINING MUST BE SQUARE, OTHERWISE FASCIA WON'T FIT CORRECTLY

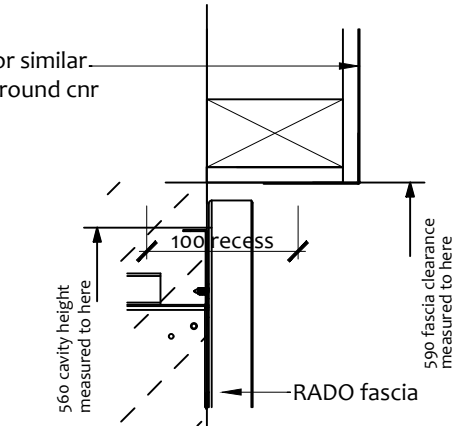

4 RECESSED HEAD
Scale: 1:5

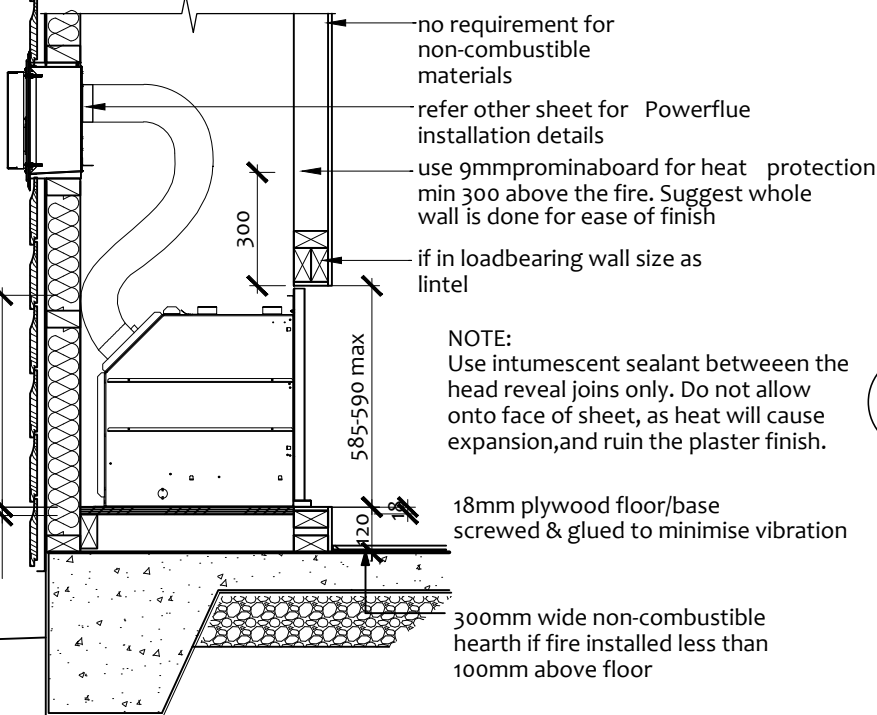

2 CROSS SECTION
Scale: 1:20

NOTE: ELECTRICIAN TO PROVIDE EASILY ACCESSIBLE ISOLATING POWER SWITCH TO APPLIANCE, AND NETWORK CABLE BACK TO ROUTER

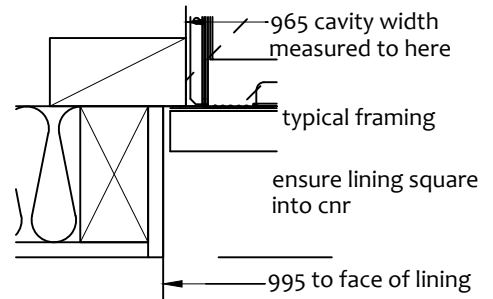

5 RECESSED JAMB
Scale: 1:5

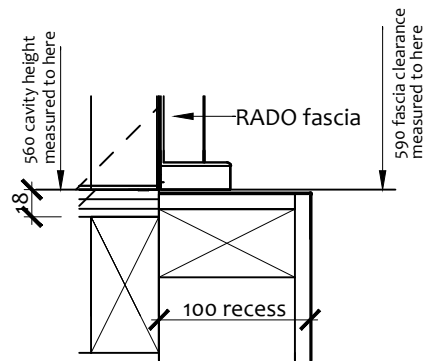

6 RECESSED BASE
Scale: 1:5

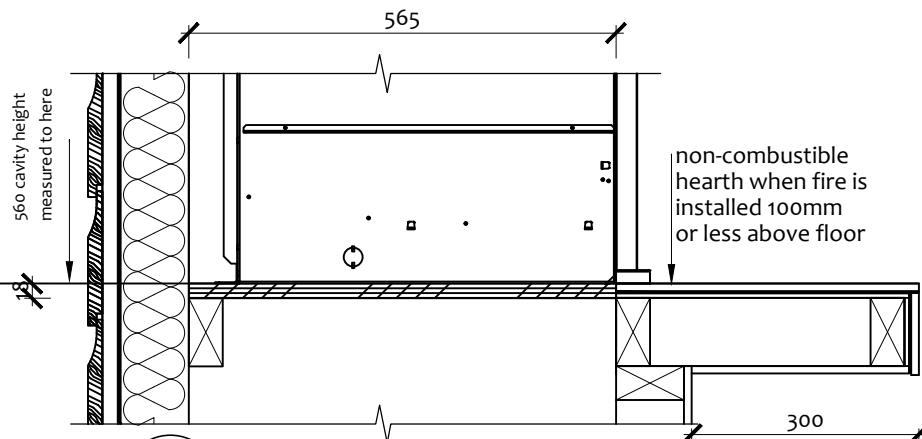

3 FLOOR DETAIL
Scale: 1:10

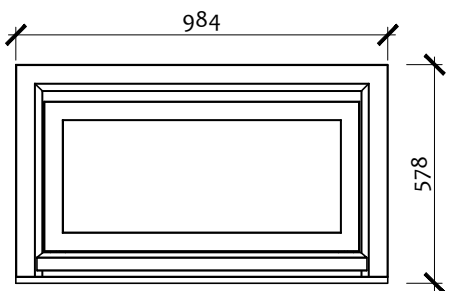

4 FASCIA DIMENSIONS
Scale: 1:20